

## Warnings!

请注意!



The rack, chassis or guide rails may cause scratches, please be careful.

机柜或者服务器机箱、导轨可能造成划伤!

When installing new servers into the rack in use, please be aware of electric shock.

在正在使用的机柜中安装新服务器时, 请谨防触电!

- When installing 2U or bigger servers, at least 2 people are needed.  
安装2U或更大的机型时, 至少需要2个人。
- During the installation process, please don't block the vents on the server, especially the vents on the front and rear of the server.  
安装时请注意不要阻塞服务器上的通风孔, 尤其是服务器前、后部的通风孔。
- Please remove the protective film on the server surface before using.  
请在使用之前将服务器外壳上的保护膜撕去。
- Please leave 15cm minimum of clearance on the front and rear sides of the server for proper ventilation.  
服务器的前、后部需至少留出15厘米空间, 以便于系统散热。
- Please install air baffles for the position without device installed, to make sure that the server can get enough air flow, and to avoid air turbulence in the server room.  
没有安装设备的机柜位置, 请始终安装挡风盲板, 以确保服务器获得足够的气流, 并避免机房气流紊乱。
- Servers are high-power electrical appliances, and they should be installed into the dedicated cabinets with vents or professional water-cooled cabinets, to prevent system failures caused by overheating.  
服务器是高功耗电器, 只能安装在带有通风孔的专用机柜, 或者专业水冷机柜中, 以免过热造成系统失效。
- If it needs to install more than one device, please load from the bottom up, and load the heaviest items first.  
如果要安装多台设备, 请先从机柜靠下的空位开始, 并将较重的设备安装在机柜下部。
- Please note the cabinet's bearing capacity, power supply capacity and heat dissipation capacity, be sure not to install devices beyond the cabinet's bearing capacity.  
请注意机柜的承重、供电及散热能力, 切勿安装超出机柜承载能力的设备。
- For the convenience of using the front and rear ports of the server and cabling, leave 70mm minimum of clearance between the front end of the server and the inner side of the cabinet's front door, and leave 150mm minimum of clearance between the rear end of the server and the inner side of the cabinet's rear door.  
为了便于使用服务器前、后部的接口, 并便于布线, 服务器前部与机柜前门内侧之间至少留出70毫米、后部与机柜后门内侧之间至少留出150毫米距离。



V01501M000000000

# Rack-mounted Server Installation Guide (Drop-in Rail) 机架式服务器 上架安装指南 (一体式导轨) V1.0



15kg



If the device is more than 15kg, 2 people are needed at least.

安装超过15千克的设备时, 至少需要2个人!



30kg



If the device is more than 30kg, 3 people are needed at least.

安装超过30千克的设备时, 至少需要3个人!



50kg



If the device is more than 50kg, 4 people are needed at least.

安装超过50千克的设备时, 至少需要4个人!

Please keep this document for checking in the future.

请保留本档, 以便于日后查阅。

## Identifying the Rail Kit Contents 服务器上架所需部件

Rail Kit is assembled by inner rail, middle rail and outer rail.  
导轨由内轨，中轨和外轨组成。

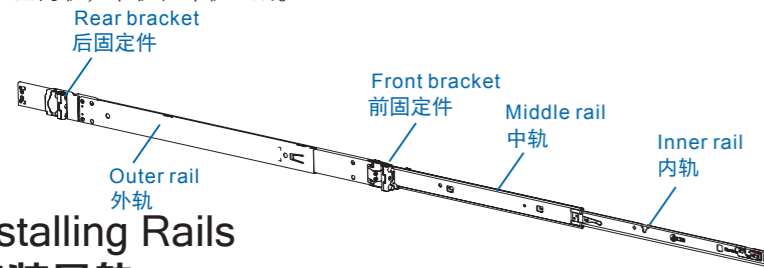

## Installing Rails 安装导轨

- Position the rear bracket and align each pin with the rack holes. ① Pull the latch release button on the rear bracket. ② Push the rail into the rack until the square pins are fully seated on the rack holes and the latch clicks into place.  
在机柜上确定好导轨后支架的安装位置，将导轨后支架上的方形锁扣和圆形按钮对准机柜角轨上的孔位，参照图中①按压后托卡勾，再依图中②箭头所示方向推导轨，直到方形锁扣完全卡入角轨孔位。

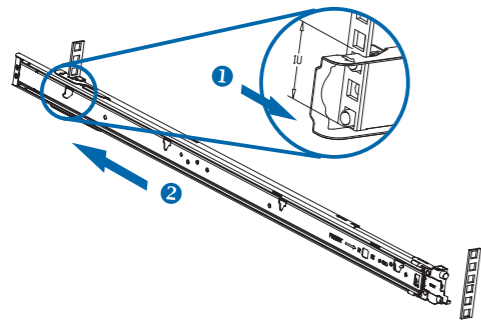

- ① Pull up the latch release part on the front bracket. ② Push the rail into the rack until the square pins are fully seated on the rack holes and the latch clicks into place.  
将前固定件的释放件参照图中①箭头拉开，再依图②箭头将导轨推入，直到方形锁扣完全卡入角轨孔位。

⚠ Notice: Keep the front and rear brackets on the same level.  
注意：一定要保持导轨的前后固定箭处于同一水平线。

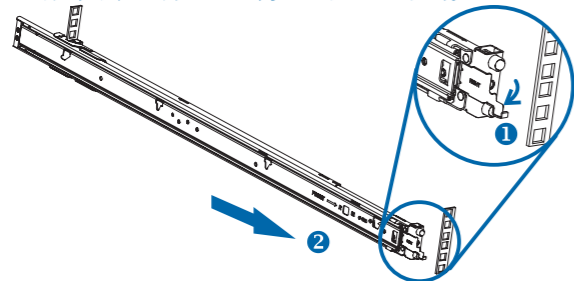

- Repeat 1 and 2 steps to install the other side. And pull the inner rails out of the rack until they lock into place.  
重复1和2步骤完成另一侧导轨的安装。然后按照图中箭头所示的方向将内轨完全打开。

⚠ Notice: Keep the left and right rails on the same level.  
注意：务必保证两侧导轨在同一水平线。

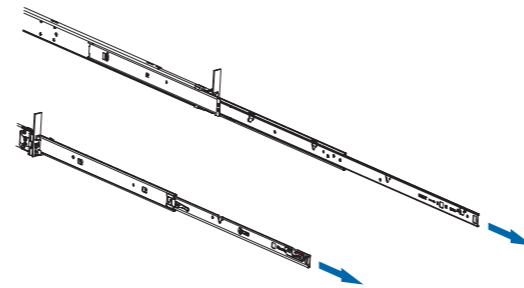

- Align the rail standoffs on each side of the system and lower them into the slots on the rail. Put the system downward until all the rail standoffs are seated in the slots.  
抬起服务器将其两侧各四个铆钉与导轨同一侧的四个铆钉槽位对齐，然后把服务器向后倾斜5°左右，将服务器后、中、前铆钉依次卡到导轨的铆钉槽位中。

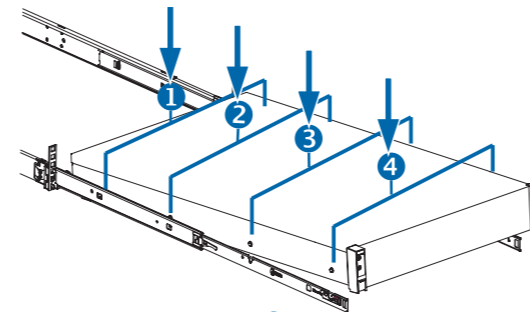

- Press the side-release lock buttons on both rails and slide the system into the rack.  
按压图中①所示的导轨两侧卡扣，将服务器按照图中②箭头所示的方向推入机柜。
- Locate and tighten the screws under each handle on the system.  
服务器推入机柜后，将服务器左右把手的螺丝固定牢固。

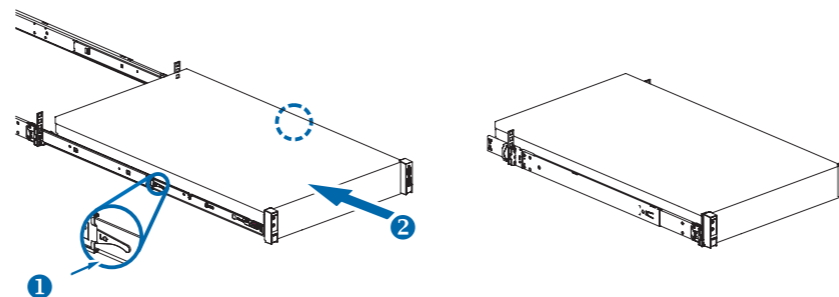

## Removing Rails 卸除导轨

- Remove the screws from the left and right handles on the system.  
将服务器左右把手的螺丝卸除。
- Pull out the system and press the side-release lock buttons on both rails, and lift the system up and away from rails.  
依图中①箭头所示将服务器拉出。拉压图中②所示的导轨两侧卡扣，将服务器向上倾斜5°左右，将服务器前、中、后铆钉依次抬出导轨的铆钉槽位。

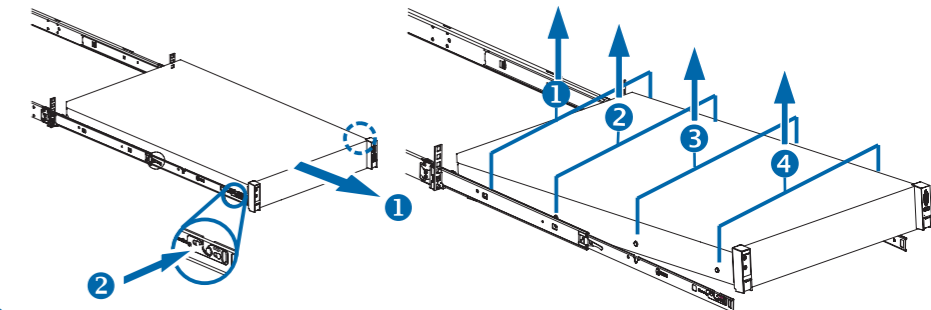

- Press the side-release lock buttons on both rails and slide the rails into the rack.  
按压图中①将内、中轨依箭头方向收回。

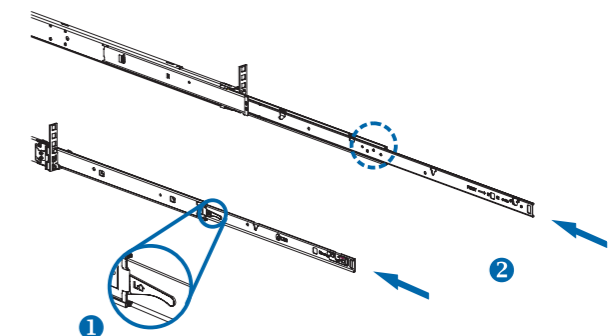

- Remove the rails as the same way of installing.  
依组装步骤拆卸导轨。

